

GOLD STRIKER

INSTRUCTION MANUAL



REG. TM

MINELAB ELECTRONICS PTY LTD

P.O. Box 35, Stepney

South Australia 5069

Phone: (08) 331 9958 Fax: (08) 331 9280

Area Codes: National (08) International (618)

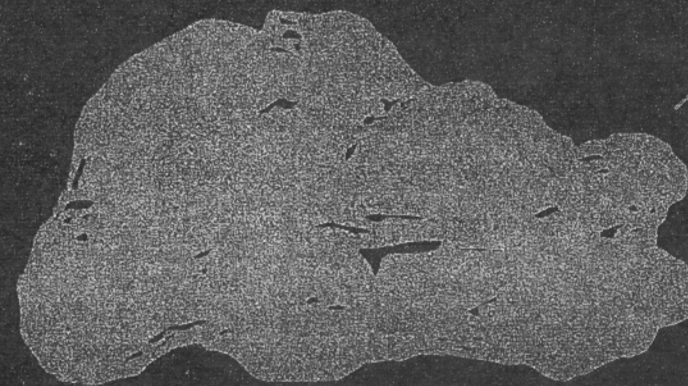

**MINELAB
ELECTRONICS
PTY. LIMITED**

<u>1. TABLE OF CONTENTS</u>	
1.	TABLE OF CONTENTS..... 1
2.	INTRODUCTION..... 2
3.	GENERAL DESCRIPTION..... 3
4.	UNPACKING AND MECHANICAL SET UP..... 3
	4.1. Shaftmounting..... 4
	4.2. Hipmounting..... 4
5.	BATTERIES..... 5
	5.1. Installation..... 5
	5.2. Battery Alternatives..... 7
6.	THE CONTROLS..... 7
	6.1. Gold Switch..... 7
	6.2. Soil Switch..... 8
	6.3. Tone Control..... 8
	6.4. Ground Tracking Switch..... 9
	6.5. Threshold Control..... 9
	6.6. Sensitivity Control..... 9
	6.7. Volume Control..... 10
	6.8. Headphone Socket..... 10
7.	OPERATING INSTRUCTIONS..... 10
	7.1. Detector Sounds..... 10
	7.2. Initial Control Settings..... 11
	7.3. Ground Balance Procedure..... 11
	7.4. Search Coil Movement..... 12
	7.5. Search Pattern..... 13
	7.6. Pin Pointing..... 13
8.	PROSPECTING TIPS..... 15
	8.1. Mineralisation and Hot Rocks..... 16
	8.2. Clay Domes..... 17
	8.3. Charcoal..... 17
	8.4. Searching For Gold..... 18
9.	ENVIRONMENTAL CONCERNS..... 18
10.	DETECTOR CARE AND TROUBLE-SHOOTING..... 19
	10.1. Proper Care of Your Detector..... 19
	10.2. Trouble-shooting..... 19
11.	WARRANTY AND SERVICE..... 20
12.	SPECIFICATIONS..... 20

2. INTRODUCTION

Congratulations on purchasing Minelab Electronics Goldstriker. This detector is a further development of the highly successful GT16000, FT16000 and XT17000. The Goldstriker continues the Minelab tradition of true automatic ground balance detectors which allow more ground to be covered in less time. It has been known for a long time that for optimum performance the interfering signals received from the ground must be "balanced out" to allow the signal received from metal targets to be identified.

Before Minelab's True Automatic Ground Balance, this function was achieved by the operator interpreting the signals produced by the detector and adjusting the Ground Balance Control (usually a 10 turn control) to compensate for the noises caused by ground mineralisation. This was a highly skilled operation which required a great deal of concentration while detecting. Any lapse in concentration so that the ground balance was poorly adjusted would most likely result in a nugget being missed. The Goldstriker uses the computing power of a microprocessor to carry out this function.

Thus the Goldstriker has several advantages over the manual Ground Balance detector in that it is constantly adjusting the ground balance to keep it correct, it is much more precise and it never tires of Ground Balancing. This enables an inexperienced operator to be using the detector with optimum performance in a very short time and the experienced operator to be detecting accurately more ground than is possible with a manual machine. We at Minelab have set out to produce the highest performance, most versatile detector available, and we wish you every success in your prospecting

Minelab Electronics Pty. Ltd.
PO BOX 35
Stepney
South Australia
5069.

3. GENERAL DESCRIPTION

The Goldstriker consists of an electronic control box and a search coil which are attached to shaft. To operate the Goldstriker you hold the shaft and sweep the search coil over the ground in order to find buried metal. The control box contains a loudspeaker, or headphones can be plugged into the headphone jack. When you pass the search coil near a piece of metal the sound heard from loudspeaker or headphones will become louder and change pitch. The Goldstriker is a "motion" detector. This means that the search coil must be moving with respect to the metal that is to be detected. If the search coil is not moving with respect to the metal object there will be no audio response

The depth below the ground's surface at which you can find metal objects depends entirely on the type of metal, its size and orientation in the ground, and the composition of the soil.

The Goldstriker's Automatic Ground Balance system will automatically compensate for signals caused by interfering ground mineralisation

4. UNPACKING AND MECHANICAL SET UP

Unpack your Goldstriker and ensure the following parts are included: Armrest, Nylon Nut and Bolt, Grey Upper Shaft, Grey Intermediate Shaft, Goldstriker Control Box, Black Fibreglass lower tube, Nylon Bolt, Nut and Spacer, Goldsearch DD 32 Coil with Skidplate, NiCad Battery Pack, Battery Charger, Nylon Carry Bag, Velcro Tabs, Instruction Manual, Field Guide and Warranty Card.

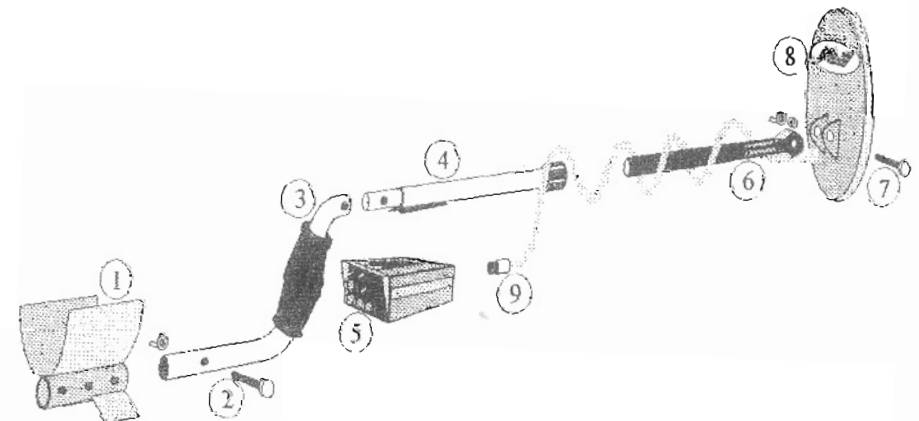

Figure 1. Goldstriker Assembly Diagram

Remove the Nylon Bolt (2) from the Armrest (1) Slide the Armrest (with support fins to the rear) over the back of the Grey Upper Shaft (3) so that holes line up at a convenient position. Push the Nylon Bolt through holes and tighten Nylon Wing Nut by hand.

Slide Grey Intermediate Tube (4) into Upper Shaft so that they "click" together, ensure box mounting clip is down.

Remove the tape that holds the Teardrop Washers in the Black Fiberglass Lower Tube (6). Remove the Nylon Bolt (7) from the bracket of the Coil (8). Push the end of the Black Fiberglass tube with the teardrop washers in to the bracket on the Coil so that the holes line up, ensure the Teardrop Washers remain in place and the clip at the other end of the shaft points away from the Coil decal. Push the Nylon Bolt through the holes in the Coil and Lower shaft. Note: the head of the Nylon Bolt will be held "captive" by the Coil Bracket. Place Nylon Spacer and Nylon Wing Nut on Bolt and hand tighten.

Slide the lower shaft assembly into the Intermediate shaft to a convenient length. Ensure the clip snaps into place. Tighten Plastic Locking ring by hand.

4.1. Shaftmounting

Slide the Control Box (5) into the clip on the Shaft until it "wedges" into place. Wind the Cable from the Search Coil around the shaft fairly tightly (but without strain), connect and screw the Cable Plug (9) to the socket on the Control Box. Experienced operators recommend that you use the Velcro Tabs to secure the Cable to the Shaft to prevent unnecessary movement and snagging on obstacles.

4.2. Hipmounting

Hipmounting is easily achieved by putting the control box (5) into the Blue Hipmount Bag, which can be threaded onto your belt, or suspended from the strap provided. Only wind approximately 3ft of cable around the shaft as above.

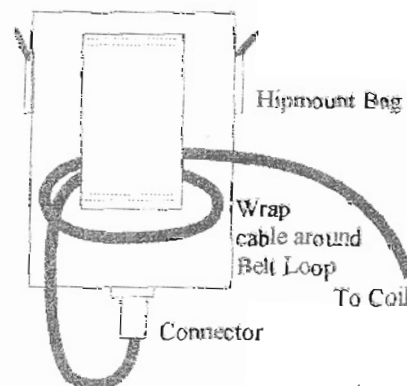

Wrap one turn of cable through the belt strap on the Hipmount Bag before plugging the connector into the control box. This is to prevent tugs on the cable straining the connector. The rest of the cable should be left "free" to allow movement of the shaft while the control box is attached to your hip. Experienced users have found strap mounting most convenient if they spend a lot of time putting down and picking up the detector while working. Be careful not to tug or stress the cable in any way as this

will deteriorate its electronic properties and introduce unwanted noise into the system.

5. BATTERIES

The Goldstriker is supplied with a Nickel-Cadmium Battery Pack. These batteries can be recharged many times, which can provide a substantial cost saving over Alkaline Batteries.

Prior to your first operation of the Goldstriker it is recommended that you charge the battery pack for 10 to 12 hours to ensure they provide peak performance in the field.

Note: When the detector is shipped the battery pack is stored in the battery compartment but not connected.

5.1. Installation

Ensure Detector is turned OFF before accessing the battery compartment.

To access the battery compartment slide the battery lid from the detector by pushing down on the front of the lid and sliding the lid out to the rear of the control box as shown in the diagram.

To connect the battery simply plug the connector from the control box into the socket on the battery.

To connect the Battery Charger unplug the battery from the control box and plug the Battery Charger in to the Battery Pack.

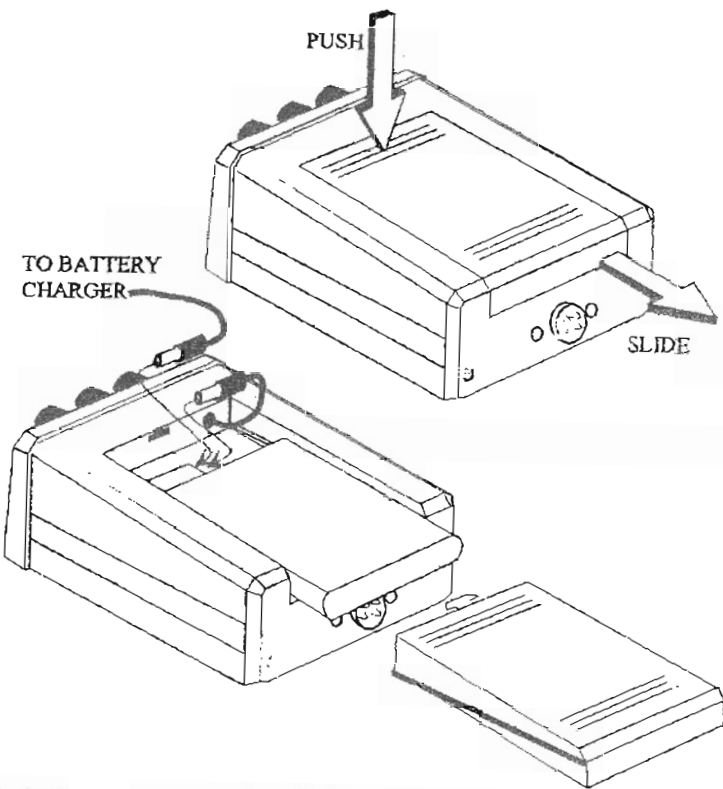

Figure 3. Battery removal and installation.

The Goldstriker has an automatic "battery low" warning system. When the battery life is critically low, a distinct sharp "pip" will sound at about 20 second intervals through the headphones or loudspeaker. These signals are quite distinctive and indicate that the batteries have about 10-15 minutes useful life left from when the sound first started.

The Goldstriker's NiCad batteries can be recharged from the supplied mains powered charger.

It is recommended that the NiCad batteries be discharged until the battery low warning has been activated. This will ensure a long life from the NiCad batteries and prevent them from acquiring a "memory".

[NiCad batteries can develop what is termed "memory" when they are repeatedly partially discharged. After some time the batteries will only operate until they are

partially discharged. This effectively reduces the amount of time these batteries will operate your detector.]

If this happens to your NiCad battery pack the "memory" can be erased by repeatedly discharging the batteries until the battery low indicator is activated and then fully recharging them. If this cycle is repeated the "memory" effect will be erased.

5.2. Battery Alternatives

If you are in the field and the NiCad batteries lose their charge, you can replace them with 8 x "AA" penlite batteries by using the optional "Alkaline Adaptor Kit". Always use high quality Alkaline batteries with this kit. **DO NOT USE CARBON BATTERIES.** We cannot guarantee the correct operation of the Goldstriker with Carbon batteries

6. THE CONTROLS

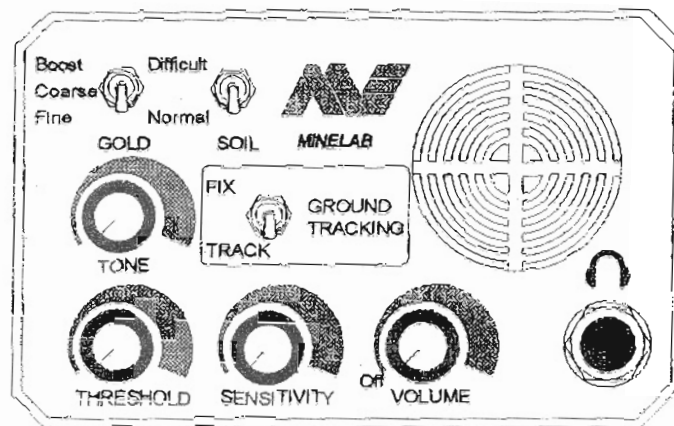

Figure 4. Goldstriker Control Panel

6.1. Gold Switch

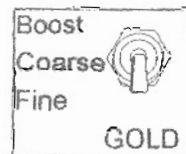

Figure 5. Gold Switch

The Gold Switch is located in the top left corner of the Control Panel. This switch will make the detection of different sizes of gold nuggets easier. There are three positions: "Coarse", "Boost" and "Fine".

In the "Coarse" position, a detected signal increases the loudness of the response as is common in most detectors. There is a small change in the pitch to help segregate target signals from the background.

This setting is recommended for prospecting for larger nuggets which could be deeply buried.

In "Boost" setting, the output signal is further amplified, offering extreme penetration in quiet or mildly mineralised soils or in a localised area. You are likely to encounter excessive "spurious" noises if you search in variable ground using this setting. Use this mode to pin-point an object which gives a faint signal under normal circumstances.

The "Fine" mode is specially designed to enable the detection of very small nuggets near the surface of the ground. In this mode, a detected signal also alters the frequency of the response. The ear is more sensitive to such changes and thereby you can detect small responses more accurately. Excessive numbers of "hot rocks" may make this mode ineffective in some grounds

6.2. Soil Switch

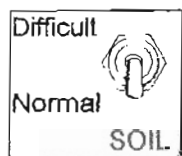

The Soil Switch is located in the centre, at the top of the Control Panel. This toggle switch should always be set on the "Normal" position for ground that is not highly mineralised.

In highly mineralised or "hot ground", which will be very noisy and produce large variable responses, the "Difficult" setting should be used. In "Difficult" the sensitivity will be reduced slightly and should be selected only for ground concentrated in ironstone or mineralisation.

Figure 6. Soil Switch

If the detector produces a high pitch "squeal", called the Overload Signal, this indicates that the ground is extremely "hot" or there is a very large object close to the Search Coil. If the Overload Signal is caused by "hot" ground, set the Soil Switch to "Difficult".

6.3. Tone Control

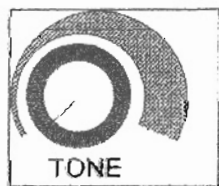

Figure 7. Tone Control

The Tone Control is located on centre left of the control panel. The Tone Control allows the operator to adjust the "tone" or "pitch" of the audio output to suit the individual.

6.4. Ground Tracking Switch



Figure 8. Ground Tracking Switch

The Ground Tracking Switch is in the centre of the Control Panel. It has two positions, Track and Fix. In both positions the Goldstriker is a motion detector; that is, the coil must be moving over the object for it to be detected. If the coil is stationary there will be no response.

In Track mode the Goldstriker is an automatic Ground Balance Detector. This means the detector continually adjusts its Ground Balance setting to maintain "tune" with the ground which will greatly reduce noises due to the ground.

In the Fix position the Goldstriker will no longer follow the changes in the ground mineralization but will remain set at the ground balance setting produced by the last use of the track position. This mode is useful when detecting over suspected deep objects after ground balancing on a nearby patch of ground. It is also useful when testing a hole for the presence of objects.

6.5. Threshold Control



Figure 9. Threshold Control

The Threshold Control is located in the bottom left corner of the Control Panel. This control is used to set the background sound level or "Threshold Tone". The Threshold Control should be set just a slight turn of the knob past the point where the tone is just audible, but not at a level where prolonged use could be irritating. If the "Threshold" is set too high or too low the very small variations in sound which can indicate very small or deep objects can be missed.

6.6. Sensitivity Control



Figure 10. Sensitivity Control

The Sensitivity Control is the centre knob at the bottom of the Control Panel. To obtain maximum sensitivity, turn the knob to its extreme clockwise setting. We recommend that in most ground you use it at its maximum setting. This setting need only be altered in poor ground conditions such as heavy mineralisation or heavy ironstone. (The Soil Switch should be used in its Difficult Setting, prior to reducing sensitivity.)

6.7. Volume Control

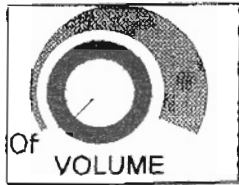

Figure 11. Volume Control

The Volume Control is located on the bottom right of the Control Panel, next to the Loudspeaker. The Goldstriker has a Volume Control which incorporates the ON / OFF switch. When the Volume Control is turned fully Anti-clockwise the Goldstriker is OFF. Turn the Volume Control Clockwise and the Goldstriker "clicks" ON.

The Volume Control is of the volume limiting type. As the Control is turned further Clockwise the maximum volume available increases while the level of the threshold volume

remains constant. This is a very useful feature when using headphones as very loud signals can be limited thus preventing ear damage, while maintaining full response to small signals.

6.8. Headphone Socket

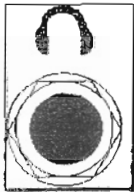

Figure 12. Headphone Socket

The Headphone Socket is located at the bottom right of the Control panel. Headphones used should be of low impedance (but no less than 8 ohms). The socket will accept most stereo headphones with a 1/4" jack. When the headphone jack is inserted, the loudspeaker is disconnected. With the headphones, you can tune the Threshold to a lower audio level and outside noises, such as wind, will be less distracting. Using the headphones also conserves battery life. If the headphones have a " Stereo / Mono" switch set it to " Stereo ".

7. OPERATING INSTRUCTIONS

7.1. Detector Sounds

There are 3 basic signals the Goldstriker will produce, these are:

Small or large variations in the volume of the Threshold Tone which are generally produced by metal objects or ground mineralisation.

Low Battery Alert. This is a sharp "pip" which will occur approximately every 20 seconds when the useful life of the batteries is at an end. See the battery section.

Overload Signal. This is a loud high pitch "squeal" which indicates the presence of a very large object or very highly mineralised ground. To overcome this raise the Search Coil or switch the Soil Switch to Difficult.

7.2. Initial Control Settings

Gold Switch: "Coarse"

Soil Switch: "Normal"

Tone Control: "Anywhere"

Volume Control: "OFF"

Ground Tracking. Switch: "Track"

Sensitivity. Control: "Max"

Threshold Control: "Min"

With the coil away from the ground or metal objects, turn the Volume Control fully clockwise. After a couple of seconds the Goldstriker will settle down.

Adjust the Threshold Control fully anti-clockwise until the sound ceases then turn the knob slightly clockwise to a point where the tone is just audible, but not at a level where prolonged use would be irritating. Adjust the Tone Control so that the tone of the threshold is to your liking.

7.3. Ground Balance Procedure



Figure 13. Ground Balance Action

Select a patch of ground where you wish to cancel out the ground noises by ground balancing the detector. Set the detector to the "Track" mode of operation. Continually raise and lower the Search Coil between 1 and 4 inches above the ground.

Initially you will hear a signal each time the coil moves in one of the two directions. After a few moments the sound will diminish until it almost vanishes. You are listening to the detector automatically ground balancing. When the sound diminishes no further, the detector is ground balanced on the chosen patch and will stay in balance when moving along by following the changes in the composition of the soil.

If the Goldstriker is initially a long way out of ground balance and the soil is exceptionally "hot" and you have difficulty bringing the machine into balance, back off by raising the Search Coil about 8 inches and pumping it more slowly.

7.4. Search Coil Movement

The Goldstriker will perform best when it is ground balanced to the surface of the ground and the coil is kept in contact with the ground. It is important to have a skid plate installed on your Search Coil. If you are rubbing the coil on the ground, in time the plastic casing will wear away. To prevent damaging your coil fit a disposable "Skid Plate" which can wear away without damaging the coil and then be replaced when necessary. (Note: Skid Plate fitted at factory.)

If you are not yet an experienced operator, you should practise maintaining constant coil height at the extremity of each swing, maintaining contact with the ground will make this easier.

Variation in coil height at the end of each swing can cause confusing sounds and will reduce detection depth. Keeping the Search Coil in contact with the ground will increase detection depth and response to very small objects.

It is important to scan an area with a broad even sweep of the Search Coil. Each sweep of the head should slightly overlap the previous sweep. However, the "Goldsearch DD 32" Coil is sensitive across its full width and therefore only a slight overlap is required.

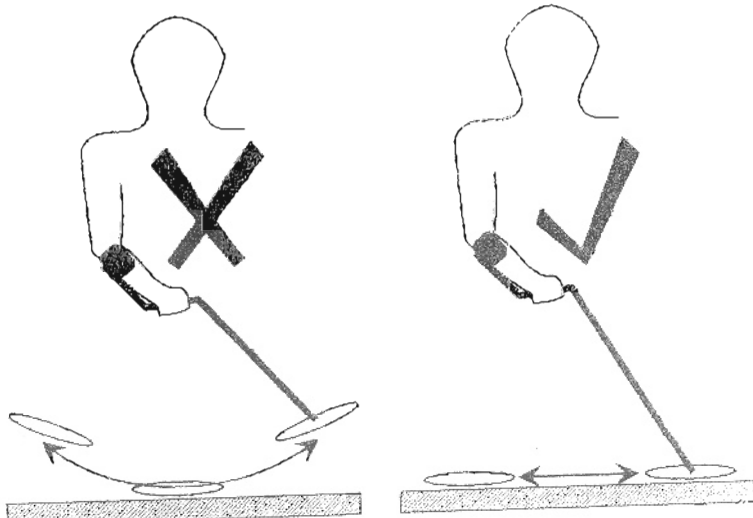

Figure 14. Coil Sweep Action

After balancing the detector will operate normally. You can now choose to stay in "Track" and continue searching or you may wish to switch to "Fix" for your searching. If you are in "Fix" mode you will need to repeat the AGB (Automatic Ground Balancing) procedure quite often in variable ground. We recommend the "Track" mode for most searching for this reason. In the "Track" mode the detector

continually adjusts its ground balance as the ground characteristics change and it thereby minimises spurious ground noises

The effective detection depth remains the same all the time, so you can search a volume of ground more accurately and rapidly than if you had to manually adjust the ground balance every time you judged that it needed readjustment. Besides covering a greater amount of ground, and making operation easier, the "Track" mode has an additional unique advantage. Its ground balance setting is really an average ground balance setting for the patch of ground most recently covered, not just for the single patch on which one conventionally balances.

Experience has shown that in most ground conditions, this significantly smooths out ground noises, while targets still give a sharp distinctive signal. The detector, on recognising an object sound, may inhibit the AGB tracking. After a short time the AGB tracking is again enabled so that continued sweeping over the object may slightly reduce the object sound as the detector tries to balance onto the object.

We recommend that for maximum effectiveness in highly variable ground, you use the "Track" mode with the Gold Switch set to "Fine"

7.5. Search Pattern

If a nugget of gold has been found there are likely to be others and a thorough search of the area from three different directions is recommended, as indicated in the three accompanying figures. This is because ground noises can vary depending on the direction the head passes across the ground. In one direction ground noises may mask out the sound of a nugget, whereas in another direction the sound may be readily discernible.

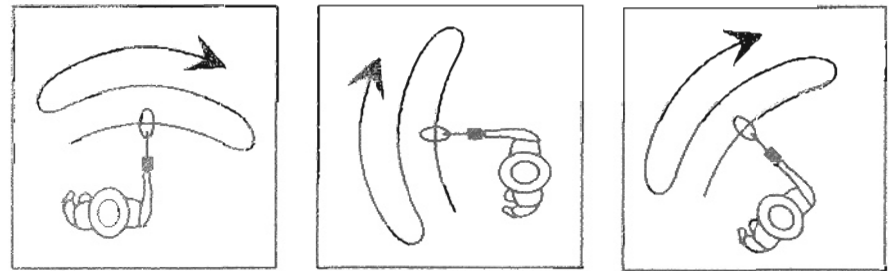

Figure 15. Recommended searching technique.

7.6. Pin Pointing

The Search Coil should pass over the ground in a smooth and even motion. It is good practice to detect an object from several directions, listening to the audio signals and taking note where they are the strongest.

The "Double D" coil can be used to pin-point a small object to within two or three millimetres using the following procedure.

Switch the Goldstriker to Fix Ground Balance. Sweep the Search Coil over the approximate position of the target. While looking at the ground note where the strongest signal occurs as the Search Coil is passed over the target

By decreasing the length of the sweeps it should be possible to determine an imaginary line on the ground which is perpendicular (at right angles) to the sweep direction and which passes through the position where the strongest signal is located. The "Double D" is sensitive across its entire width (perpendicular to the sweep direction), so the target could be anywhere on the imaginary line you have constructed where it passes under the Search Coil.

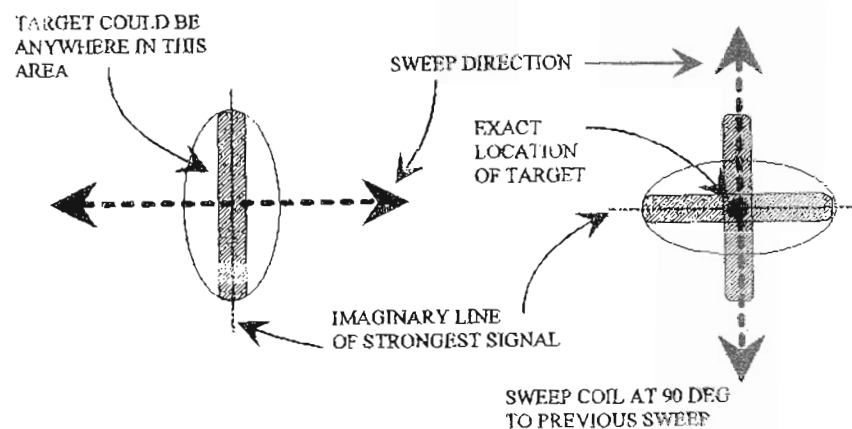

Figure 16. Pin-Pointing

To determine the exact location of the target move around this spot on the ground and repeat the above process at 90 degrees to the previous sweep. Where the two imaginary lines cross will be the exact location of the target.

After making an appraisal of the target's position, best results will be gained by removing the top inch or so of soil within approximately 6 inch radius of the target point.

Spread out the removed soil next to where there is no other likely target. By passing the coil over the flattened soil, your detector will signal if the object is small and contained in the top layer. It can be found more readily by this method than by digging a large hole.

If it is not found in the flattened soil, continue to dig and follow the same procedure. Do not leave sharp edges around the hole perimeter, because the detector could give a false reading on the edges of the hole. It is better to go slowly, otherwise the object may be lost by spreading it too far away from the area being worked, or if it is a small find you may end up burying it even deeper than when it was first detected.

When the object has been removed from the hole, ensure the Ground Balance Control is in "Fix" and lay the detector down with the Search Coil flat on the ground, close by the hole.

Gather a handful of soil at a time and place it on the Search Coil. Move the soil around on the Search Coil. When the target is moved on the Search Coil the detector will "beep" to indicate its presence.

Detect again over the hole to make sure that there are no other objects to be found (it wouldn't be the first time that gold nuggets have been found one under the other!). Remember to fill in all holes you have dug: they are dangerous, unsightly and environmentally unacceptable.

There is also a quick method for pinpointing with the "Double D" coil. It is not as accurate as the above method, but is adequate in many cases. There is a point on the edge of the coil which has high sensitivity. This point is on the opposite side of the coil as you view it in operation. If you tip the coil on edge by turning the detector upside-down then this sensitive edge is nearest to the ground.

Place a 5c piece on the ground and move this edge (while the coil is vertical and the detector is upside-down) over the coin. You will note a clear signal as the edge of the coil passes over the coin. By slightly rotating the coil and passing it backwards and forwards and side to side over the coin mark the point where the sensitivity is greatest.

This point can now be used (by using this method) to determine the position of an object with reasonable accuracy (one or two centimeters). This method is particularly suitable for determining the position of larger objects in a scrape as the depth is increased to make sure the object is still at the centre of the scrape, or quickly locating larger objects in the removed soil.

8. PROSPECTING TIPS

There is nothing more annoying than getting a signal and digging but finding nothing. This can confuse the inexperienced operator and even destroy their confidence. It will take time and practice until you can learn to recognize which signal to pay attention to and which to ignore. These interfering signals are known as "ground noises". The Goldstriker is particularly good at minimising these ground

noises and this is the reason for the exceptional depth capability, however even with this detector some ground noises will occur particularly in heavily mineralised ground.

8.1. Mineralisation and Hot Rocks

Typically mineralised ground can make a detector respond with an indication that there might be an object reasonably deep beneath the surface. The sound could be rather broad and not very loud, or sometimes crisp and reasonably sharp.

Other noises which most affect detectors are "hot rocks". These are rocks rich in iron which can have very strong audio signals. With the strong ones, some detectors have problems in tuning them out, but with the Goldstriker signals from hot rocks are not as great a problem.

If you find a broad "positive" sound which you feel is probably due to mineralisation but is positive enough to make you suspect a possible deep object, pass the Search Coil in a circular path around the centre of the positive sound source, while maintaining the closest edge of the Search Coil about 2 to 3 inches from this centre.

After 2 or 3 rotations (1 to 1.5 seconds each) pass the coil directly over the centre and listen to the "positiveness" of the signal. Repeat this procedure but this time with Search Coil at right angles to the previous orientation and pass the coil over the positive sound centre at right angles to the first pass.

If both passes result in a significant positive response, dig! As the hole gets deeper keep checking for the presence of the signal by passing the detector over the hole at ground level (not at the level of the bottom of the hole). If the signal remains clear you may well be onto something (obviously removing ground will not weaken object signals), on the other hand if the signal becomes fainter and more diffuse i.e. seems to be more spread out then the source of the signal is probably ground noise. However, keep digging until you are sure.

It is possible for gold nuggets to be entirely encased in rocks so thorough checking is necessary to ensure no gold is missed. Breaking rocks in two, then passing each section of the rock across the Search Coil, one after the other, will determine which piece contains the gold.

Sometimes "negative" hot rocks or ground "holes" are encountered. In this case the sound from the detector is reduced as it passes over the rock or "hole". The detector, on recovering from this loss of sound, can give an audible signal which to the beginner may be confused with the sound of an object. Experience will soon enable the operator to recognise this characteristic sound which is in fact quite different from an object.

In particular, pay careful attention to the point on the ground corresponding to the supposed signal. If the point is displaced by about the width of the coil as the coil passed across the "object" then the signal is probably due to negative ground effects or negative "hot" rocks. In these conditions the Fine Gold Mode may well be useful in reducing this problem.

8.2. Clay Domes

A common occurrence in nugget bearing country is soil mineralisation which is commonly known as "clay domes". These are regions of rather broad sound which can be confused with the sound which would come from a deep large nugget. The following procedure will quickly establish whether or not the sound comes from clay or a metal object.

Remove about 1.5 inches of soil in a broad 12 inch diameter circle with no sharp edges. This will allow the Search Coil to approach the "object" by about 1.5 inches. Now with the coil in this lowered position over the hole attempt to ground balance the signal.

If ground balance can be achieved then this source of sound is probably clay, since it is not possible to ground balance a metal object which has been brought closer to the coil. In addition, the signal from a metal object is greatly enhanced when the object is brought even slightly closer to the head, whereas the clay, because it is not concentrated does not produce a greatly enhanced signal even when the head can be lowered.

Be careful that the edges of the shallow hole are not producing spurious signals. The technique requires practice and experience but it is essential to develop a good technique to avoid digging many deep holes unnecessarily.

8.3. Charcoal

Charcoal can sound loud at times and rather like a metallic object when close to the surface. Charcoal is usually created by farmers burning off tree stumps or by bushfires. The growth is burnt below the ground level, so it is not always obvious what the sounds are until you have actually dug up the causes of these noises a few times.

Again, experience will teach the operator how to read the ground efficiently and gain understanding of the detector's response to the ground. One indicator that it is charcoal is that the sound seems more spread out than the object and becomes more patchy as the ground is dug, however for inexperienced operators it is best to continue to dig until the reason for the signal becomes clear. (Note: Once the charcoal is removed from the ground the signal will vanish.)

8.4. Searching For Gold

To have a good chance of detecting gold, it is necessary to search out areas where "course gold" is known to have been found, or other areas where it is likely to occur. The term "course gold" refers to gold ranging in size from a grain of wheat to many grams and in some cases hundreds of grams.

Many nugget bearing areas are the result of broken down gold reefs containing quartz and ironstone. Experienced prospectors learn to "read the ground" and look for tell-tale signs indicating potential gold bearing fields. It is a fascinating and exciting hobby to learn some of these skills and apply them in your search for gold.

The modern metal detector has given today's prospector enormous advantages over the prospectors of old. The ground can be rapidly scanned until a small piece of gold is found and then a study of the area made to decide where other gold nuggets are likely to be located. It is then best to make a systematic search of the area.

The main problem encountered while using metal detectors is the presence of heavy concentrations of ironstone. This is particularly the case in some of the richest known fields in Australia or the "black sands" areas of North America. It appears that gold nuggets and ironstone often go together, and in fact many gold nuggets have ironstone embedded in them or are encased in ironstone and others show strong ironstone staining. Some of these fields have only been superficially worked because of the interference to the detector caused by the ironstone. Usually only the most persistent professional is prepared to spend the time and the energy necessary to cope with these conditions, and then only partially.

9. ENVIRONMENTAL CONCERNS

Firstly it should be pointed out that prospecting with a metal detector is the most environmentally friendly way to recover gold. Other methods require the use of toxic chemicals such as cyanide or mercury. It is very important to leave an area that you have searched in at least the same condition that you found it in.

All holes that have been dug must be refilled properly. Not only is it environmentally unacceptable to not fill in your holes it is dangerous as well.

Take any junk that you find or produce away with you to dispose of properly. Leaving an area "scarred" can result in action being taken to prevent the use of metal detectors and spoiling this fascinating hobby for others as well as yourself. This has already happened in many productive areas which are now lost to the detector operator.

10. DETECTOR CARE AND TROUBLE-SHOOTING

10.1. Proper Care of Your Detector

The Goldstriker is a high quality electronic instrument, finely engineered and packaged in a durable housing. Taking proper care is mostly common sense.

Do not leave batteries in the Control Box when the detector is not in use for a period exceeding two weeks. Damage caused by leaking batteries can be severe and would void the warranty through user negligence.

If temperatures are very high, do not leave the detector in the sun longer than necessary. Covering it from direct sunlight will help protect it. Try to avoid leaving it in a closed trunk or the car sitting in the sunlight.

The Search Coil housing will wear through if you scrub the ground with it while searching. We recommend that you use an easily replaceable skid plate to protect it, and replace it before it wears out.

The bag is designed to protect the Control Box, especially from dust, mist and rain it will also cushion potentially damaging knocks. Use the bag where possible.

Whilst the Control Box has been designed to be water resistant, it is not waterproof. Avoid wetting it unnecessarily. Never allow the box to come into contact with petrol or other oil based liquids.

Should the Search Coil be used in salt water, it must be washed with fresh water. Keep the unit dry and clean and avoid getting sand and grit into the shafts or the tightening nuts. Do not use solvents to clean the detector. Use a damp cloth with mild soap detergent.

10.2. Trouble-shooting

If your detector is not performing satisfactorily please check the following:

Batteries. Many detector problems are caused by flat or faulty batteries. Ensure the NiCad batteries are correctly maintained- see batteries section. If using penlite or "AA" cells only use Alkaline batteries.

Cables. Ensure the Coil cable is in good condition and not subject to undue stress.

Interference. The Goldstriker is a very sensitive VLF radio receiver. There are many external sources of noise that may affect the performance of the detector; these include: another detector in close proximity, high power transmitters, power lines and electric fences.

11. WARRANTY AND SERVICE

There is a two year parts and labour warranty on the Goldstriker. Refer to your Warranty Card for details. The Search Coil is warranted for one year. Refer to your supplier or Minelab for service, either in or out of warranty.

NOTE: This warranty is not transferable, nor is it valid unless the enclosed warranty registration card is returned to Minelab Electronics Pty. Ltd. or an authorised Minelab Electronics Pty. Ltd. regional distributor within 14 days of the original purchase, for the purpose of recording the date, which is the actual commencement of the warranty.

The Minelab warranty does not cover damage caused by accident, misuse, neglect, alteration, modifications or unauthorised service. For specific details of the Minelab warranty please refer to the machine's 'Product Warranty Card'.

12. SPECIFICATIONS

(subject to change without notice.)

Length	Max	4' 6"	
	Min	3' 10"	
Weight	Complete (Exc. Batt.)	31b 5oz	
Configuration	Shaftmount	Yes	
	Hipmount	Yes	
Transmission	Single Frequency VLF	32kHz	
Ground Rejection	True Automatic Ground Balance	Yes	
Search Modes	Track GB, Motion with Threshold	Yes	
	Fix GB, Motion with Threshold	Yes	
Controls	Threshold + On/Off	1T	
	Sensitivity	1T	
	Volume	1T	
	Tone	1T	
	Gold	3Pos Sw	
	Soil	3Pos Sw	
	Ground Tracking	2Pos Sw	
	Audio O/P	Moisture resistant loudspeaker	Yes
		1/4" Headphone Jack	Stereo
Overload	High pitch tone	Yes	
Batteries	12V NiCad Pack 600mA or greater	Yes	
	Duration	10-15Hr	
Search Coil	10" Elliptical	10x5.5"	
	Winding	DD	
	Weight	11b	
	Cable Length	8' 6"	
Patents	US 4894618, AUS 595835, CAN 1260146, US 4890064, others pending.		